

Passive Radar - From Inception to Maturity

Hugh Griffiths
Senior Past President, IEEE AES Society
2017 IEEE Picard Medal
IEEE AESS Distinguished Lecturer
THALES / Royal Academy of Engineering Chair of RF Sensors
University College London

OUTLINE

- Introduction and definitions
- Some history
- Bistatic radar properties: geometry, radar equation, target properties
- Passive radar illuminators
- Passive radar systems and results
- The future ...



BISTATIC RADAR: DEFINITIONS

- **MONOSTATIC RADAR**
Tx & Rx at same, or *nearly the same*, location
- **BISTATIC RADAR**
Tx & Rx separated by a *considerable distance* in order to achieve a technical, operational or cost benefit
- **RADAR NET**
Several radars linked together to improve **coverage*** or accuracy
- **MULTILATERATION RADAR**
Radar net using range-only data
- **MULTISTATIC RADAR**
Bistatic radar net with multiple Tx's and/or RX's.
- **HITCHHIKER**
Bistatic Rx operating with the Tx of a monostatic radar
- **PASSIVE BISTATIC RADAR**
Bistatic Rx operating with other Tx's of opportunity

*** Enjoys the union of individual coverage areas.** All others require the intersection of individual coverage areas.

Coverage area: (SNR + BW + LOS)

BISTATIC RADAR

- Bistatic radar has potential advantages in detection of stealthy targets which are shaped to scatter energy in directions away from the monostatic
- The receiver is covert and therefore safer in many situations
- Countermeasures are difficult to deploy against bistatic radar
- Increasing use of systems based on unmanned air vehicles (UAVs) makes bistatic systems attractive
- Many of the synchronisation and geolocation problems that were previously very difficult are now readily soluble using GPS, and
- The extra degrees of freedom may make it easier to extract information from bistatic clutter for remote sensing applications

FIRST PASSIVE BISTATIC RADAR

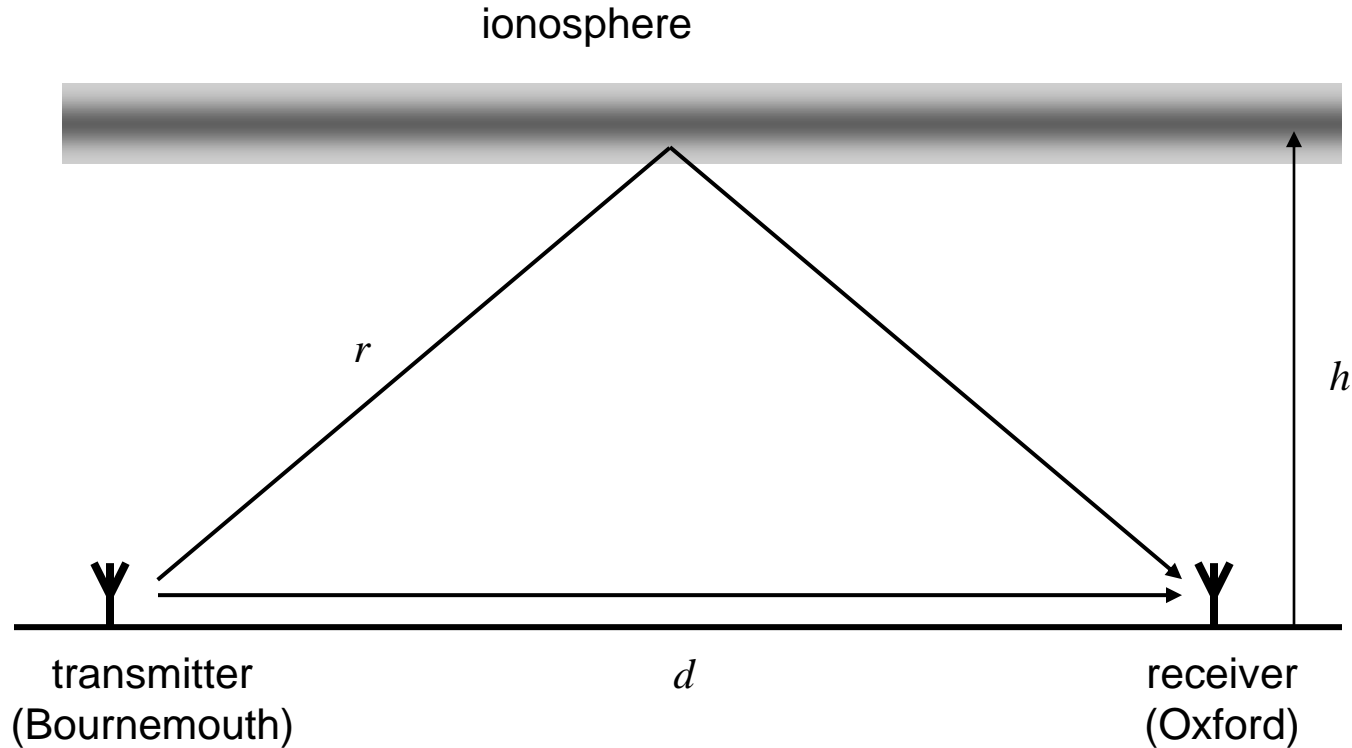

$$t = \frac{2r - d}{c}$$

$$h = \frac{\sqrt{c^2 t^2 + 2ctd}}{2}$$

Appleton, E.V. and Barnett, M.A.F., 'On some direct evidence for downward atmospheric reflection of electric rays', *Proc. Roy. Soc.*, Vol.109, pp261-641, December 1925. (experiments at end of 1924)

THE DAVENTRY EXPERIMENT: 26 FEBRUARY 1935



The BBC Empire transmitter at Daventry gave a beam 30° azimuth \times 10° elevation at 49 m wavelength, and the beat note from a Heyford bomber at a range of 8 miles was clearly detected.

THE DAVENTRY EXPERIMENT: 26 FEBRUARY 1935

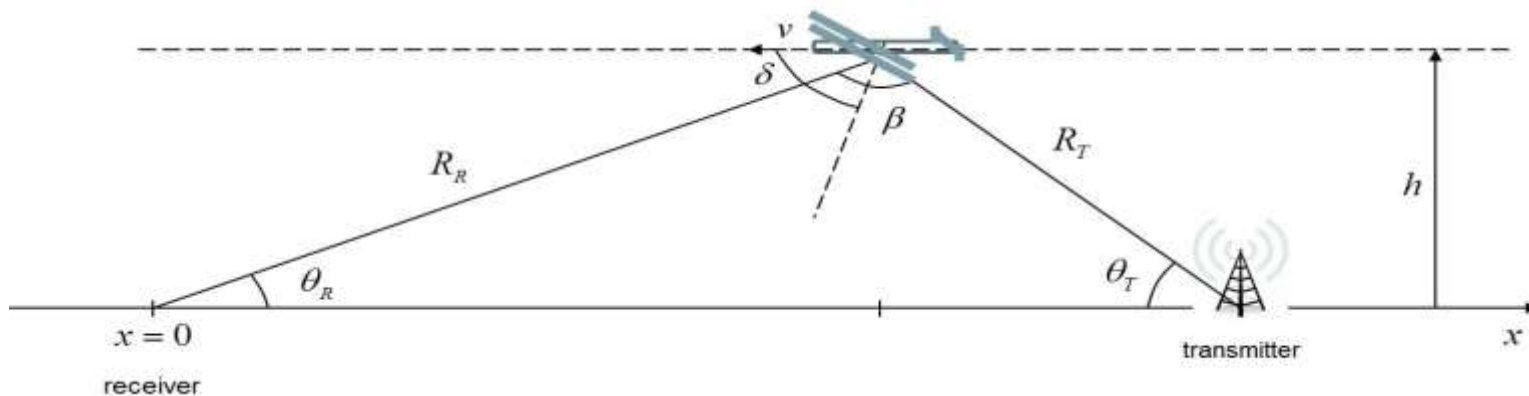
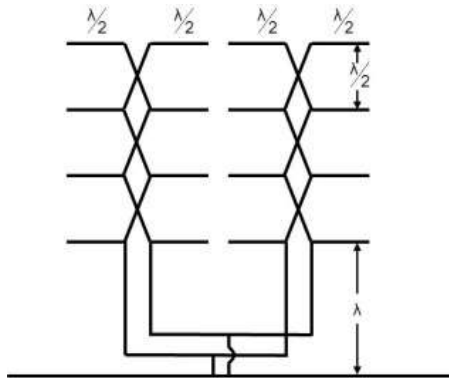

THE DAVENTRY EXPERIMENT: 26 FEBRUARY 1935

From Watson Watt: 'The hum of the expected Heyford from R.A.E. became audible, and we watched him fly by at about 6,000 feet towards Daventry. His instructions were to shuttle at that height to-and-fro on a twenty-mile long beat from Daventry, on a course up and down the centre-line of the radio beam. He made only a fair job of holding the requested course, no one of his four runs took him right over our heads, but three passed very close.'

From Wilkins: 'The second approach was nearer the beam axis but still some way off and this time rhythmic beating of the re-radiated signal with a small direct signal allowed through the receiver was noted. As the aircraft subsequently flew off to the south good beats were observed and, calculating from the time interval from the airspeed requested (100 mph), we estimated that we had followed the aircraft for about eight miles''.

$$P_R = \frac{P_T G_T G_R \lambda^2 \sigma}{(4\pi)^3 R_T^2 R_R^2}$$

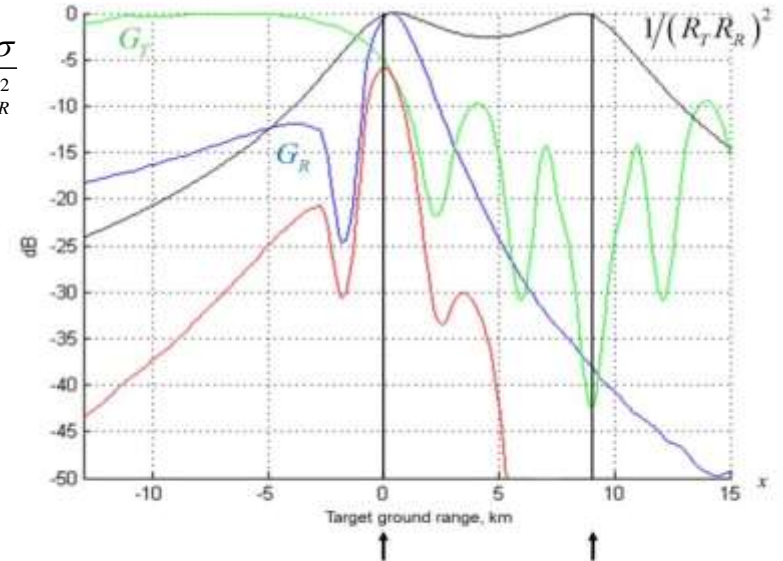

$$f_D = \frac{2v}{\lambda} \cos \delta \cos \beta / 2$$

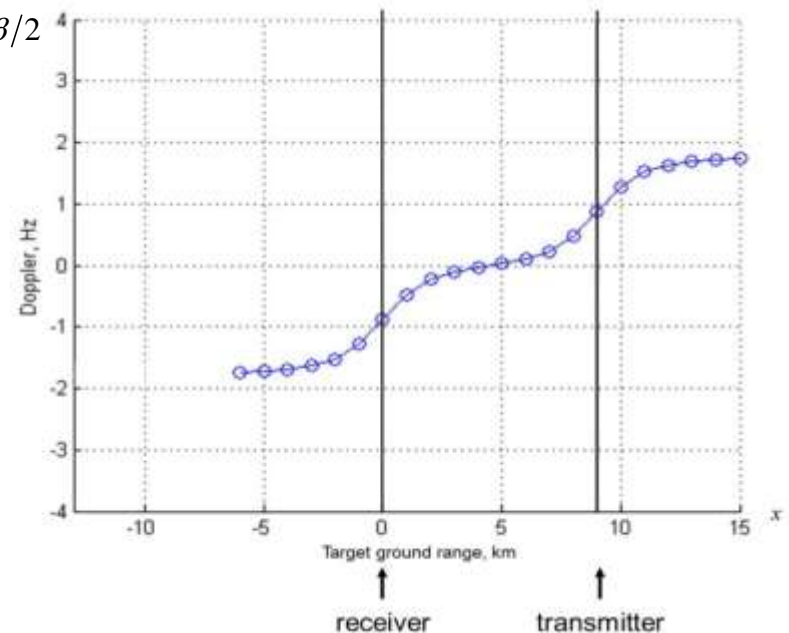

CHAIN HOME

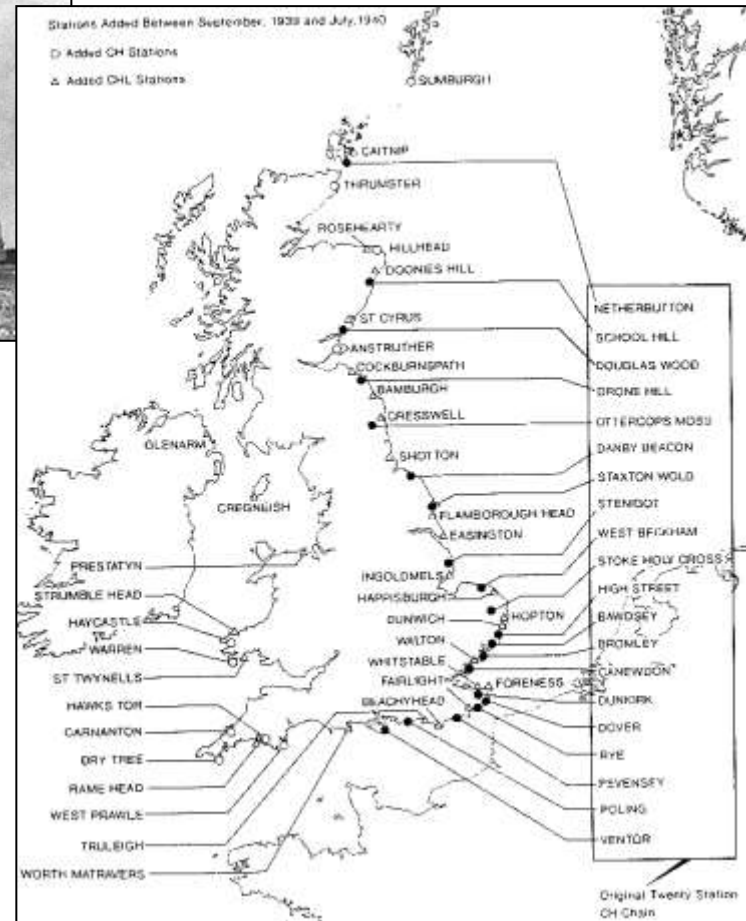
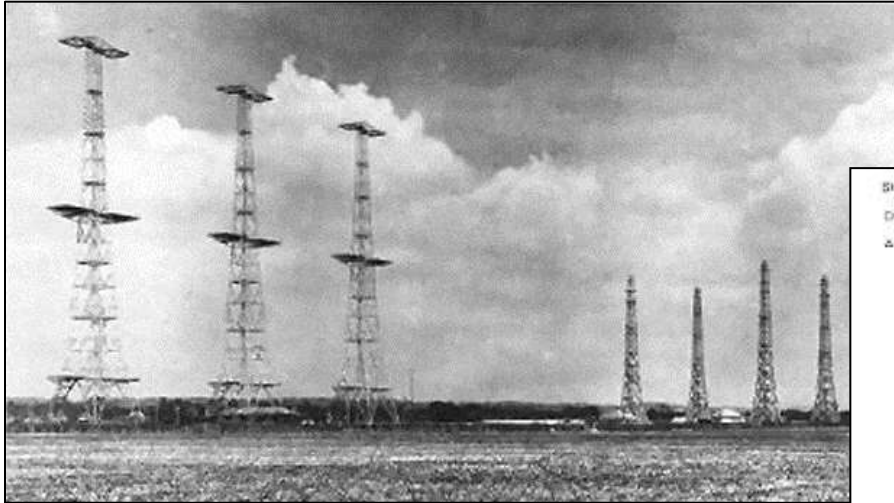

KLEIN HEIDELBERG

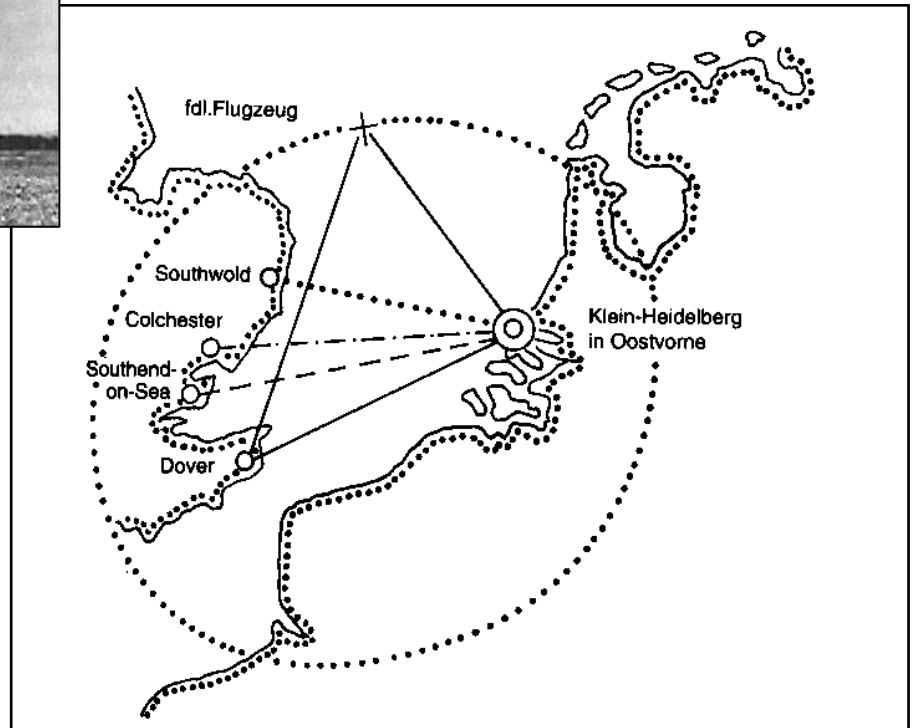
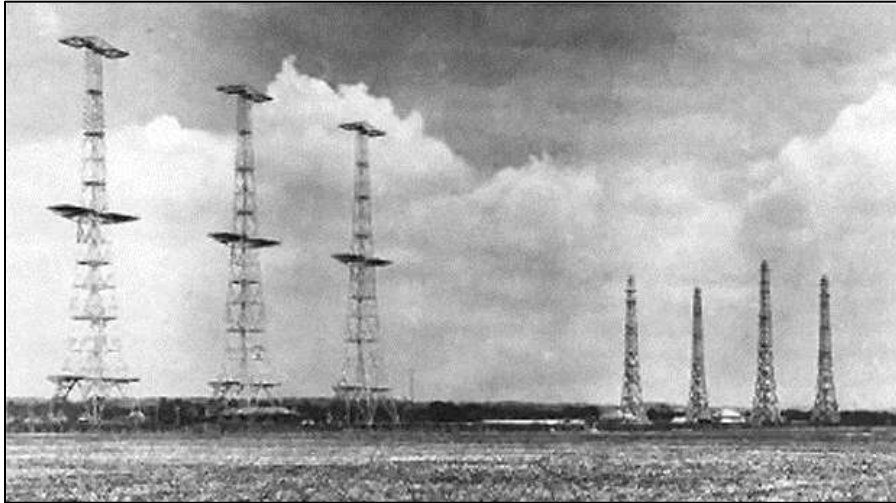

KLEIN HEIDELBERG

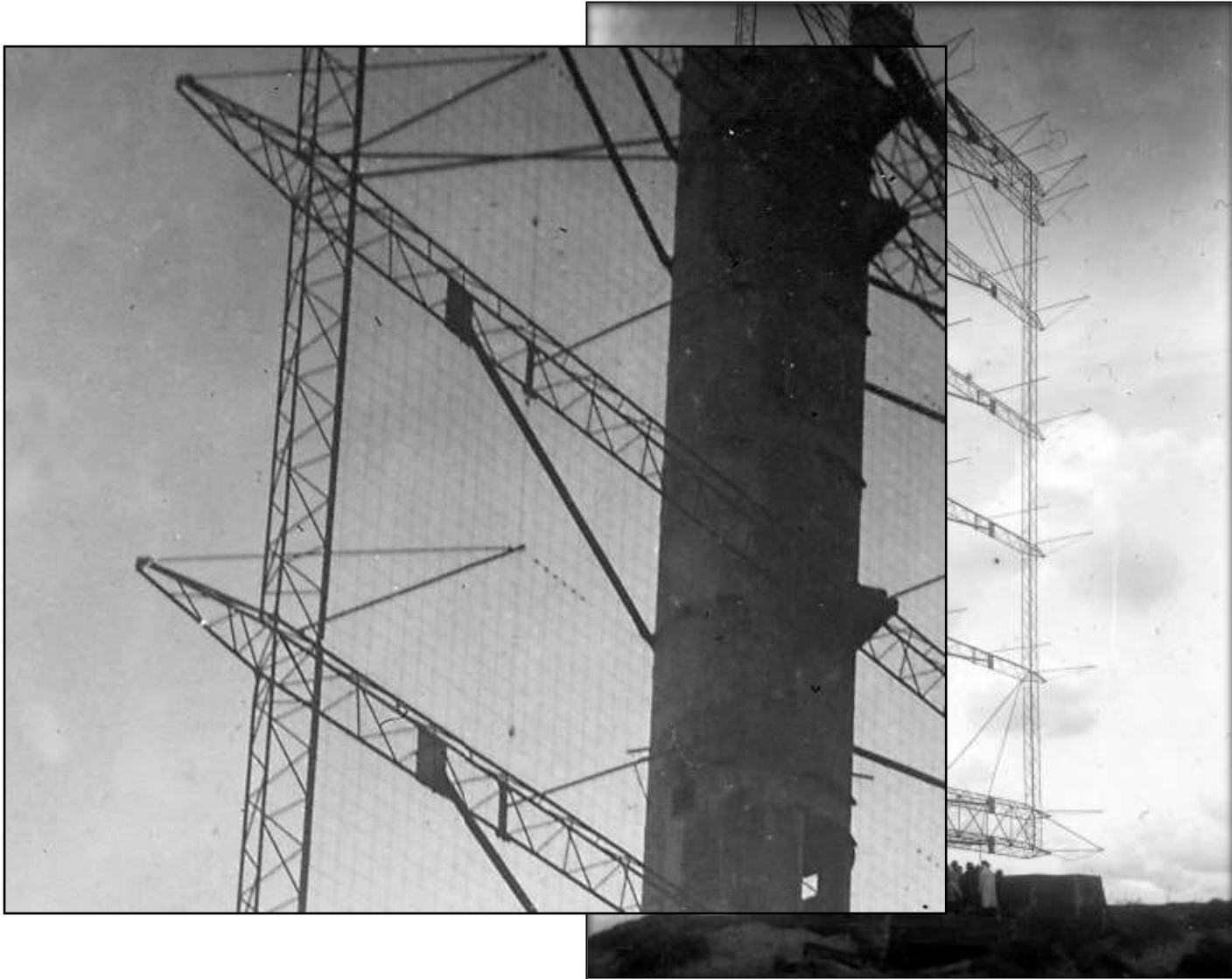

KLEIN HEIDELBERG *STELLUNGEN*

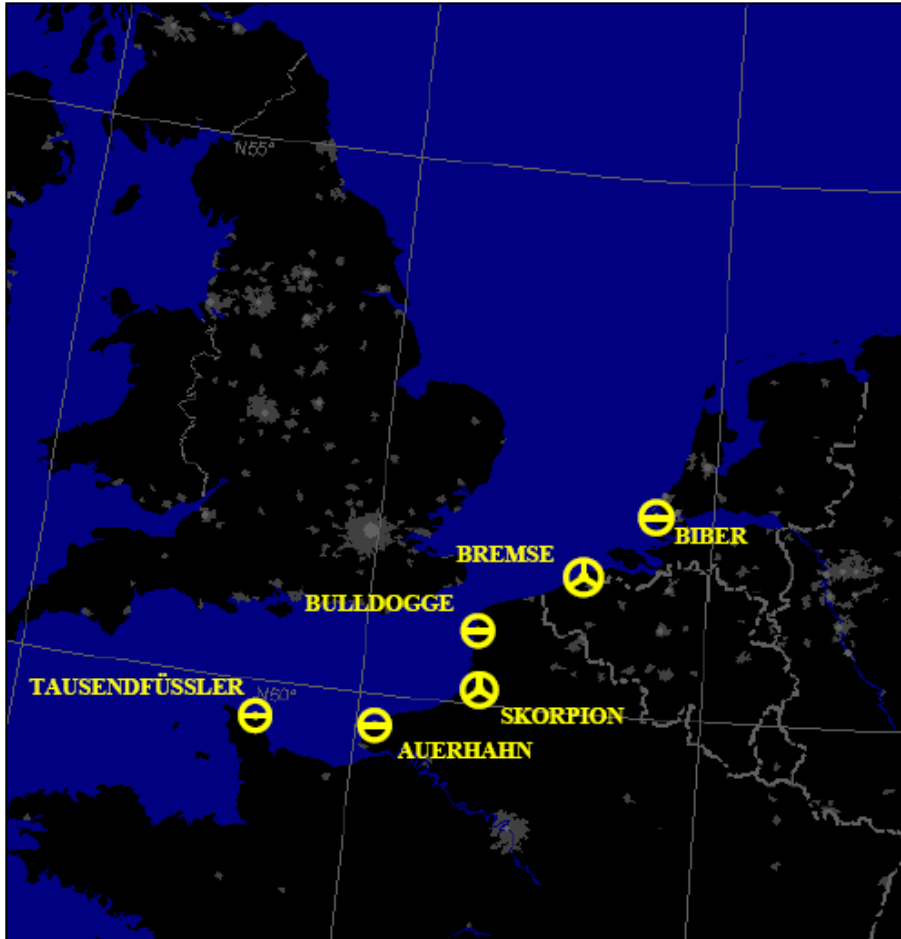

There were six KH *Stellungen* (sites):

BIBER (Oostvoorne)
BREMSE (Ostend)
BULLDOGGE (Boulogne)
SKORPION (Vaudricourt, Abbeville)
AUERHAHN (Cap d'Antifer)
TAUSENDFÜSSLER (Cherbourg)

Some sources also include Castricum (Netherlands) and Rømø (Denmark), but these were ELEFANT and SEE-ELEFANT/RÜSSEL radars, whose receive antennas were similar to those of KH.

 1st order *Stellungen*

 2nd order *Stellungen*

TOP SECRET

AIR SCIENTIFIC INTELLIGENCE

INTERIM REPORT

HEIDELBERG

This Report is not to be shown outside the following distribution without the authority of A.C.A.S.(I).

WAR CABINET

Lord Cherwell 23

ADMIRALTY

N.I.D.9. 24

AIR MINISTRY

Secretary of State. 1
C.A.S. }
V.C.A.S. } 2
D.C.A.S. }
A.C.A.S.(Ops.). 4
D.B.Ops. 5
D.of Ops. (A.D.). 6
D.A.T. 7
A.C.A.S.(I). 8
D.A.C.A.S.(I). 9
D.of I.(C). 10
D.of I.(R). 11
D.D.I.4. 12
A.I.3(b). 13
A.I.3(U.S.A.). 14
Colonel Douglass,U.S.A.A.F. 15-16
C.of C. 17
D.G.of S. 18
D.of Tels. 19
D.of Radar. 20
S.A.T. 21
S.A.A.L. 22

H.A.P.

D.C.D. 36
Chief Superintendent,T.R.E. 37

COMMANDS

A.C.of S., A2., S.H.A.E.F. 25
Deputy A.C.of S., A2. 26
(Sigtnt), S.H.A.E.F.
C.S.O., Bomber Command. 27
C.I.O., Bomber Command. 28
C.S.O., Fighter Command. 29
C.I.O., Fighter Command. 30
Commanding General, 31
U.S.S.T.A.F.
Commanding General, 32
U.S. 8th Air Force.
A.O.C., 100 Group. 33
A.O.C., 60 Group. 34
U.C., 80 Wing. 35

INTRODUCTION

1.1. The enemy has been attempting to use the radiations from our own CH stations to plot our aircraft through the Mandrel screen. The evidence from the various sources is reviewed and possible countermeasures are considered.

INTELLIGENCE

2.1. A.D.I.(K) has provided the only direct evidence; this comes from the interrogation of a prisoner, previously a Wassermann operator, who was posted last May to the Wassermann site at Abbeville / Vaudricourt. According to his story the apparatus was equipped with a receiver, but no transmitter. Plots were obtained by locking on to the pulses from the Dover CH station. The maximum range claimed each day was usually about 450 Km; the range accuracy was said to be ± 10 Km.

2.2. The method is simple. The reading on the range tube gives the difference between (i) the distance from the CH to the Wassermann and (ii) the length of the path CH - aircraft - Wassermann. Since (i) is fixed and known, this determines (ii). Hence the aircraft must lie on an ellipse whose foci are the CH and the Wassermann. The position of the aircraft on the ellipse is then determined by taking a bearing. The prisoner declared that the Wassermann also gave the height of the aircraft.

2.3. The prisoner referred to the presentation unit of the Wassermann as "Heidelberg".

2.4. The Wassermann at Vaudricourt is known from photographic evidence to have a wider array than normal. This has only been seen on seven apparatuses, some of which carry the normal array as well. They are listed below.

Limeon / Duinont	52° 35' 02" N	04° 37' 22" E
Oostvoorne / Zeehonden	51° 54' 16" N	04° 03' 30" E
Ostend / de Mahn	51° 16' 49" N	03° 02' 56" E
Boulogne Monument	50° 44' 46" N	01° 36' 52" E
Abbeville / Vaudricourt	50° 07' 00" N	01° 32' 00" E
Cap d'Antifer	49° 40' 24" N	00° 09' 45" E
Cherbourg / La Brasserie	49° 40' 05" N	01° 28' 10" W

The Boulogne Wassermann had the large array by about August 1943. The remainder were not completed until towards the end of the year.

2.5. The German Air Signals Experimental Regiment is known to have a detachment at Oostvoorne. They refer in their correspondence to an apparatus called Klein Heidelberg. Since we know that there is a Wassermann at Oostvoorne similar to that at Vaudricourt, we may reasonably suppose that they are for the same purpose. The relation between Heidelberg and Klein Heidelberg is not known, but it is assumed to be close.

2.6. A further detachment of the Air Signals Experimental Regiment is known to have arrived at Oostvoorne in December 1943

from Boulogne. Oostvoorne was not operational at that time but it was expected to be so shortly. It looks therefore, as if the Boulogne site was operational during the later part of 1943 and that experienced personnel from there had been sent to start up the Oostvoorne site.

2.7. We have no further information concerning the remaining sites.

2.8. Captured documents dated November 1942 have referred to "Heidelberg" being under development.

VALUE TO THE ENEMY

3.1. From the above evidence it seems clear that the enemy has used the method, if only on a small scale. During the first half of this year he was getting from his radar, and latterly from his route-tracking organisations, an abundance of information which would have observed any additional long range plots obtained by the Heidelberg method. The present situation is something of a mystery however. For the last few months his main trouble in deploying his night fighters has been lack of early warning owing to the Mandrel Screen and to radio silence on the part of the bomber force.

3.2. It is inconceivable that the enemy would neglect any available method of obtaining early warning. Hence he must have encountered some difficulty, of whose nature we are unaware, in using this system, at least on the Dutch stations. While the present picture is not clear, the method represents a threat to our bomber offensive which we cannot neglect.

OTHER SUITABLE TRANSMISSIONS

4.1. In order to be fairly sure of getting a plot over any desired area by this method it is only necessary that the transmitter concerned be of reasonably high power and wide angle, and emit suitably sharp pulses. Apart from the CH's themselves, the CH stand-by sets (42-50 Mc/s) and the Gee transmitters are the most suitable. Although there is as yet no evidence that the enemy is using the latter transmissions, we should bear the possibility in mind.

POSSIBLE COUNTERMEASURES

5.1. Provided that we can be reasonably sure of identifying the responsible apparatuses a simple countermeasure would be to destroy them. The main difficulty is that, while we can be reasonably sure of identifying Chimneys on the coast, we cannot be sure of finding them inland, nor of finding other types of apparatus which might be used.

5.2. It has been proposed as a countermeasure to put two CH stations on the same frequency and "jitter" their pulses. This would not be satisfactory because (i) the enemy could employ a directional aerial, and so select whichever station he preferred, and (ii) even if he did not do this but merely

triggered his time base at every direct pulse, he would only develop an ambiguity, which could probably be resolved by a few minutes' plotting, and which would in any case give him the early warning he so badly wants.

5.3. With the CH stations and their stand-by stations two better radio-countermeasures suggest themselves. The first and obvious one is to switch them off as the Mandrel Screen comes on. A second and rather nicer one is to fit a "Moonshine" modification so as to provide the enemy with false plots. It would be possible in this way to decide whether or not the enemy is at present using the method; we could easily simulate a force of bombers flying across the North Sea and observe the enemy's reactions. If successful the device could be used to provide so many false alarms that he could no longer trust the observations.

5.4. Should he decide to use Gee transmissions, radio-countermeasures might be difficult without interfering with our own use of this aid. In this case destruction of the receiving apparatuses responsible may be the best alternative.

24.11.44.

A.D.I. (Science).

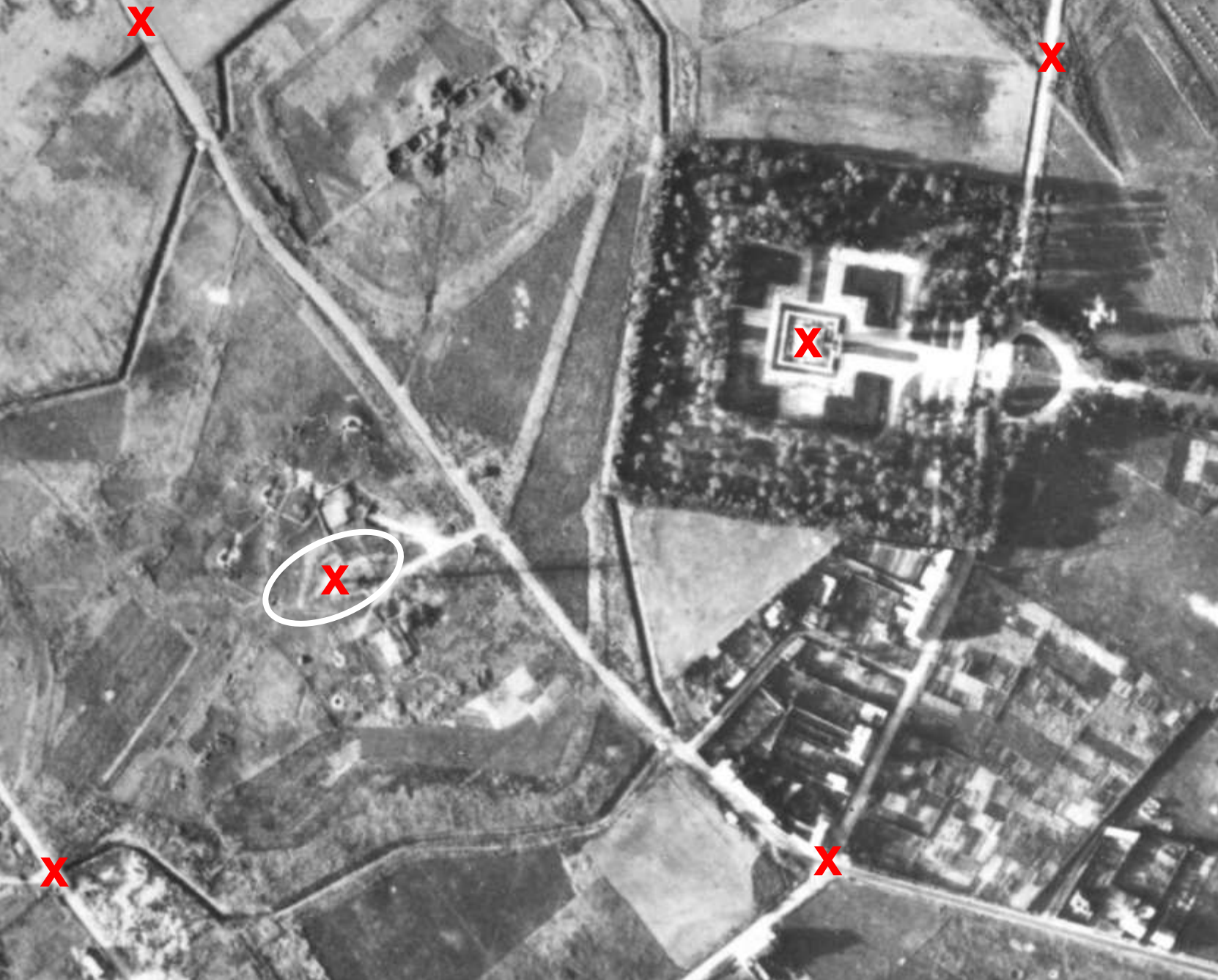



KLEIN HEIDELBERG



Stellung BIBER, Oostvoorne)

KLEIN HEIDELBERG



L480 Bunker (*Stellung BIBER, Oostvoorne*)

BISTATIC RADAR GEOMETRY

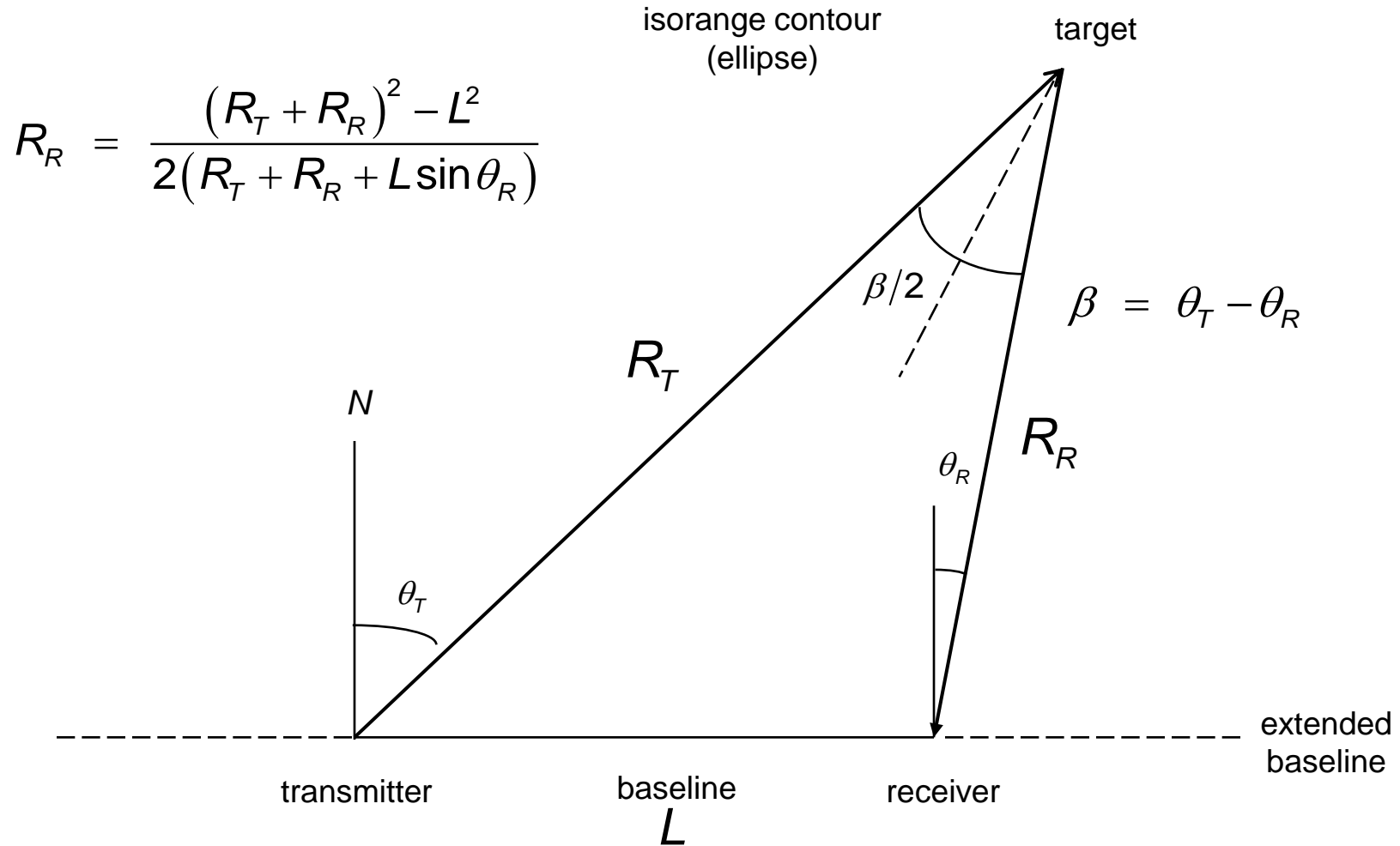

BISTATIC RADAR GEOMETRY

Contours of constant bistatic range are ellipses, with the transmitter and receiver as the two focal points

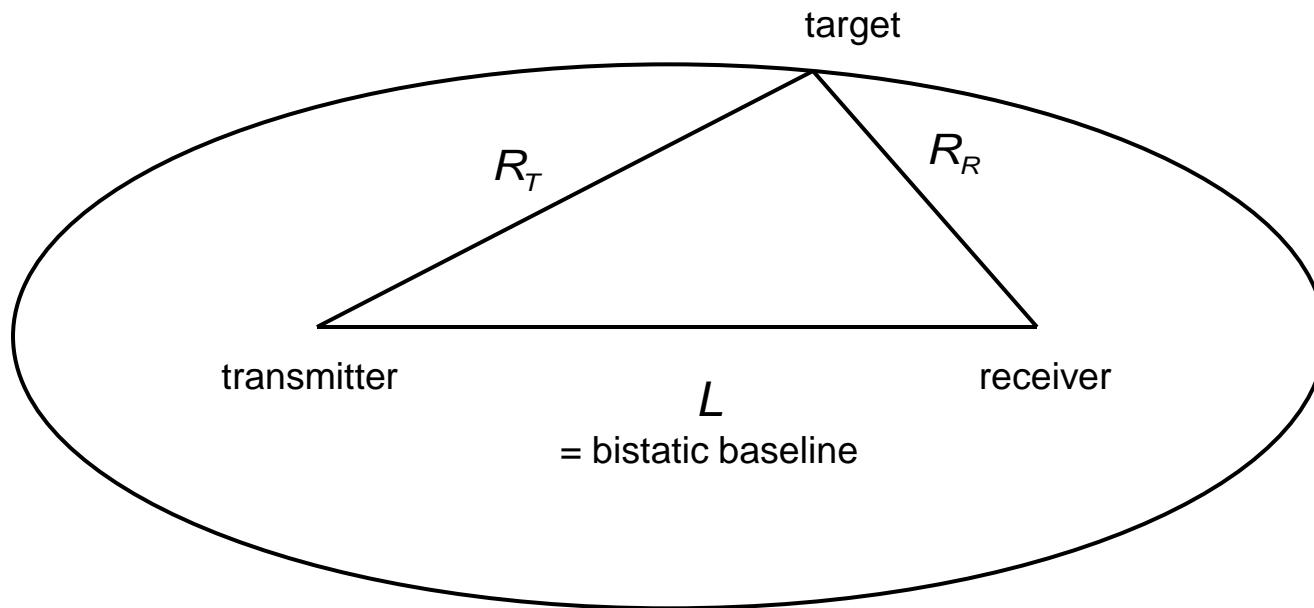

$$R_T + R_R = \text{const}$$

Targets lying on the transmitter-receiver baseline have zero bistatic range.

BISTATIC RADAR DOPPLER

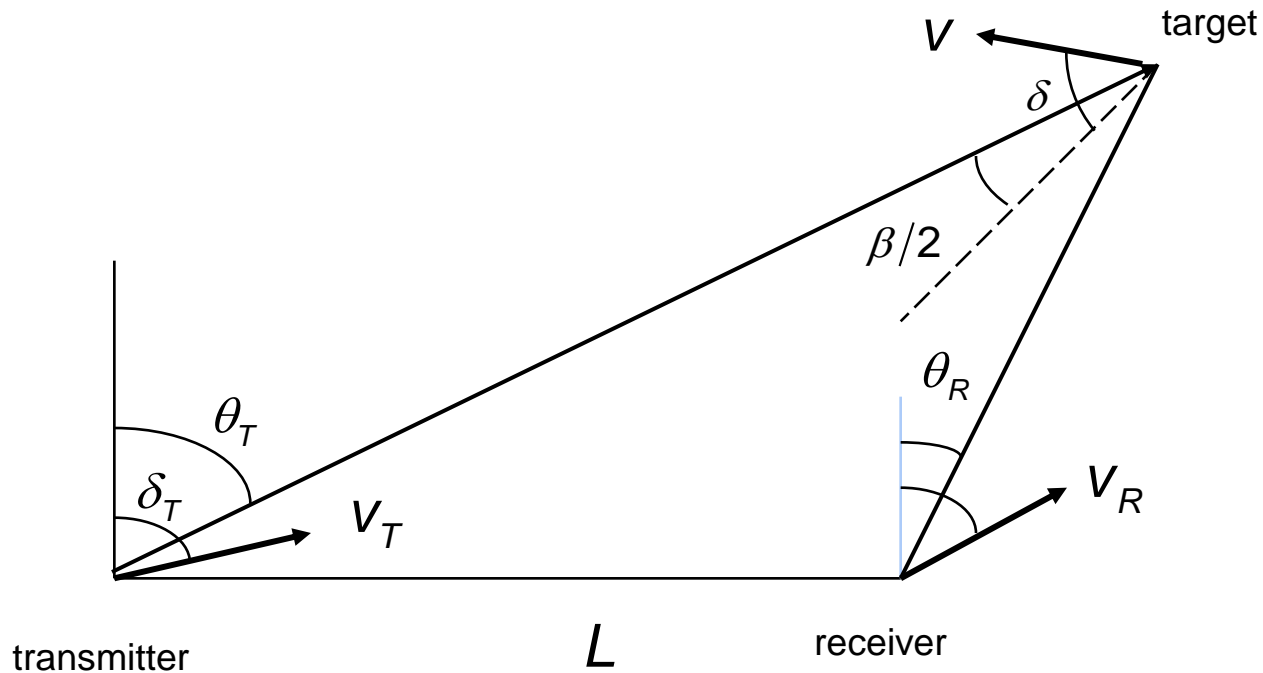

$$\beta = \theta_T - \theta_R$$

BISTATIC RADAR DOPPLER

For $V_T = V_R = 0$; $V \neq 0$ $f_D = \left(\frac{2V}{\lambda} \right) \cos \delta \cos(\beta/2)$

special cases :

β	δ	f_D	<i>condition</i>
0	–	$(2v/\lambda) \cos \delta$	<i>monostatic</i>
0	0	$(2v/\lambda)$	<i>monostatic</i>
180	–	0	<i>forward scatter</i>
–	± 90	0	<i>v \perp to bisector</i>
–	$\pm \beta/2$	$(2v/\lambda) \cos^2(\beta/2)$	<i>v \Rightarrow tx or rx</i>
–	0,180	$\pm (2v/\lambda) \cos(\beta/2)$	<i>v \Rightarrow bisector</i>
–	$90 \pm \beta/2$	$\mp (v/\lambda) \sin \beta$	<i>v \perp to tx or rx LOS</i>

BISTATIC RADAR EQUATION

This is derived in the same way as the monostatic radar equation :

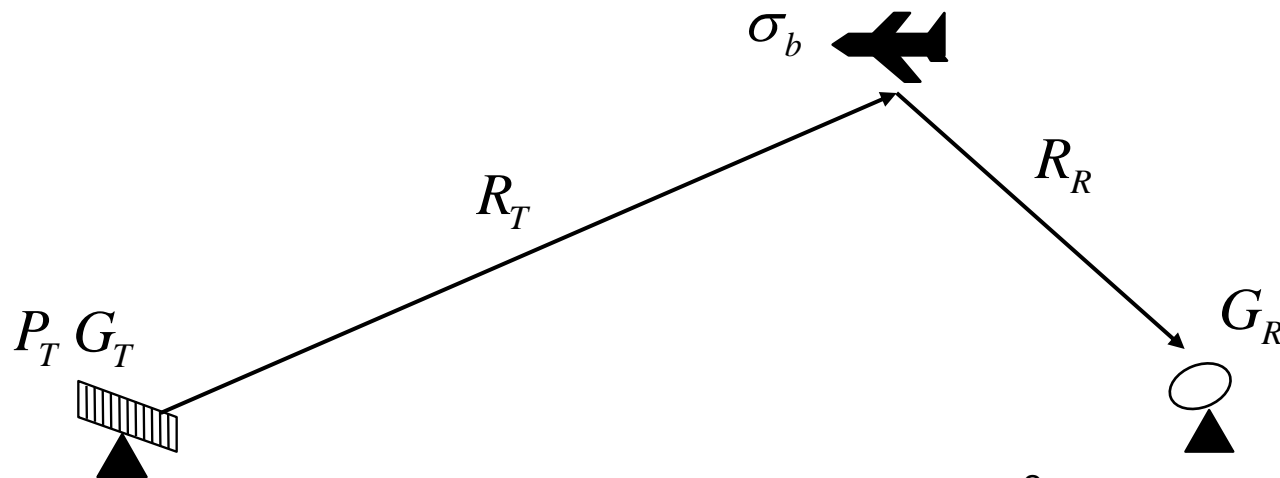

$$\frac{P_R}{P_N} = \frac{P_T G_T}{4\pi R_T^2} \cdot \sigma_b \cdot \frac{1}{4\pi R_R^2} \cdot \frac{G_R \lambda^2}{4\pi} \cdot \frac{1}{kT_0 BFL}$$

$$= \frac{P_T G_T G_R \lambda^2 \sigma_b}{(4\pi)^3 R_T^2 R_R^2 kT_0 BFL}$$

The dynamic range of signals to be handled is reduced, because of the defined minimum range.

BISTATIC RADAR EQUATION

We can see from the bistatic radar equation

$$\frac{P_R}{P_N} = \frac{P_T G_T G_R \lambda^2 \sigma_b}{(4\pi)^3 R_T^2 R_R^2 k T_0 BFL}$$

that contours of constant detection range are defined by $R_T R_R = \text{constant} = c$.

These are *Ovals of Cassini*

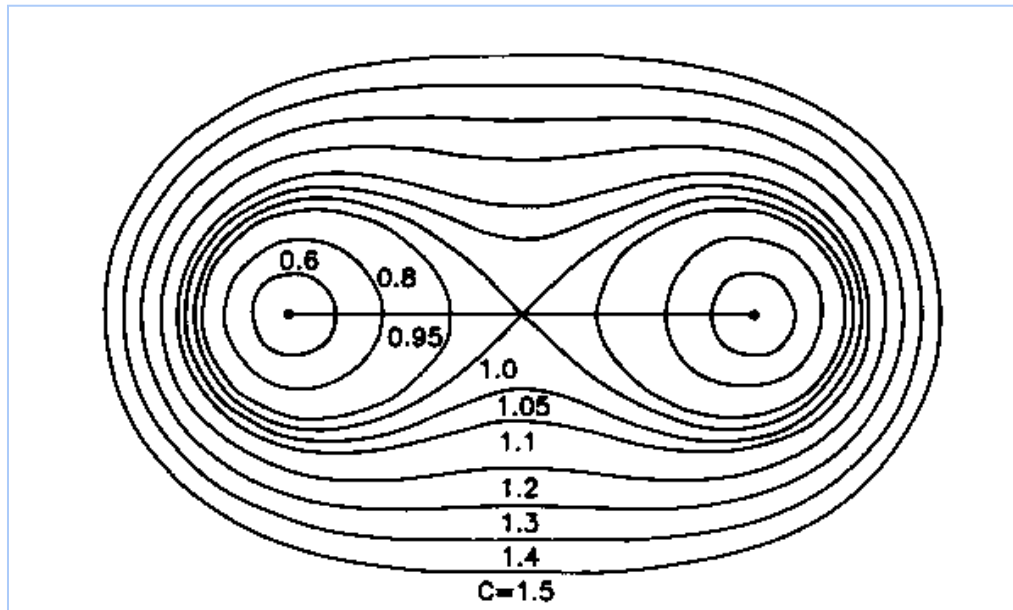

RESONANCE SCATTER

- The resonance scatter effect for monostatic radars has been well documented for conventional (non-stealth) targets. In the simplest case of a conducting sphere of radius a , resonance occurs in the region $0.5 < 2\pi a/\lambda < 10$.
- “Physically, the resonant region can be explained by the interference between the incident wave and the creeping wave, which circles the sphere and either adds to or subtracts from the total field at the leading surface” (Barton)
- The net result of these additive effects is that when wavelengths are of the order of discrete aircraft dimensions, for example fuselage, wing, tail, inlet and exhaust ducts, the resulting resonance significantly enhances RCS when compared to the optical region, which for the sphere starts at $2\pi a/\lambda > 10$.

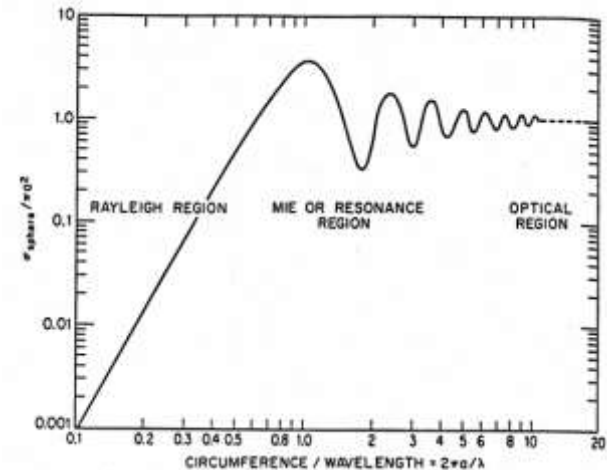

RESONANCE SCATTER

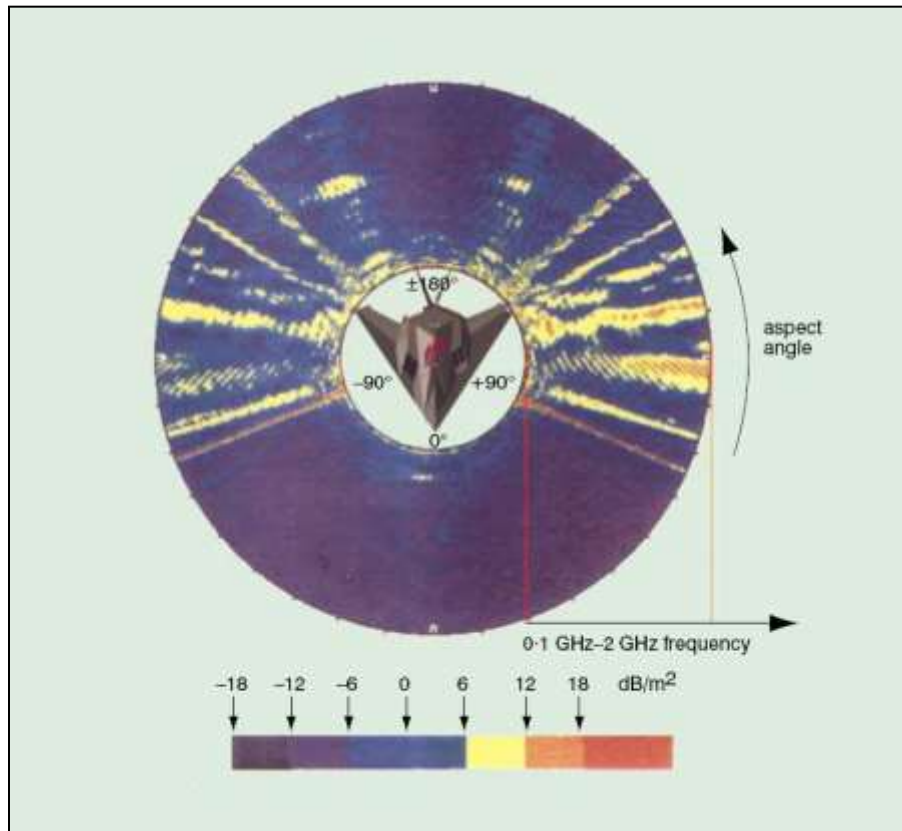

Kuschel, H., 'VHF/UHF radar, part 1: characteristics; part 2: operational aspects and applications', *Electronics and Communications Journal*, Vol.14, No.2, pp 61-72, April 2002, and Vol.14, No.3, pp 101-111, June 2002.

Deutsche Aerospace, Bremen anechoic chamber measurements of a faceted, metallized 1:10 scale model of an F-117 aircraft:

“The aircraft geometry was obtained from open literature and hence the target model does not take into account fine structure details and surface materials such as RAM, which are of less importance at VHF/UHF...”

“The scaled measurement results... show that the attempt to reduce the target's RCS has been successful in the $\pm 70^\circ$ section around the nose-on aspect and for the frequency range above 400 MHz. High RCS values covering the whole frequency range occur when the direction of illumination is perpendicular to the front or back edges of the wings or other dominant structures of the fuselage. In the nose-on section, however, an increase in the RCS can be seen at VHF around 100 MHz [6 to 10 dBm^2] and UHF around 400 MHz [0 to 6 dBm^2 , > 6 dBm^2 nose on] due to resonance effects. Hence, such stealth techniques can be efficient at high radar frequencies but are ineffective at VHF/UHF.”

FORWARD SCATTER

Babinet's principle tells us that we get exactly the same scattering from a perfectly-absorbing target as we would from a target-shaped hole in an infinite perfectly-conducting sheet !

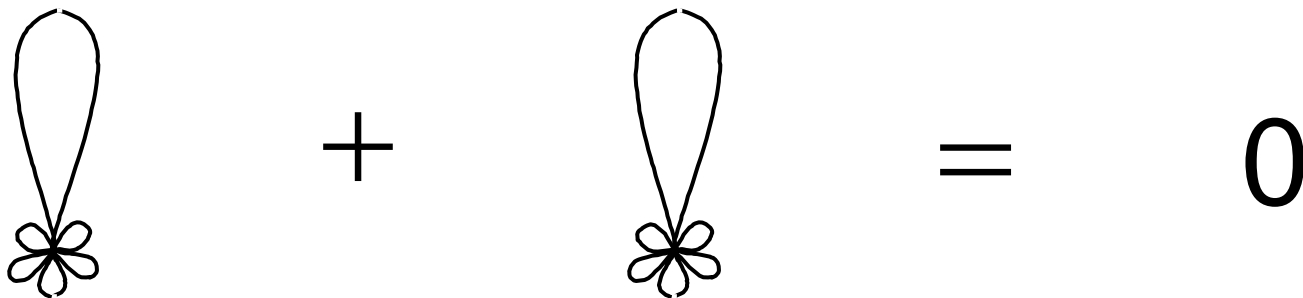
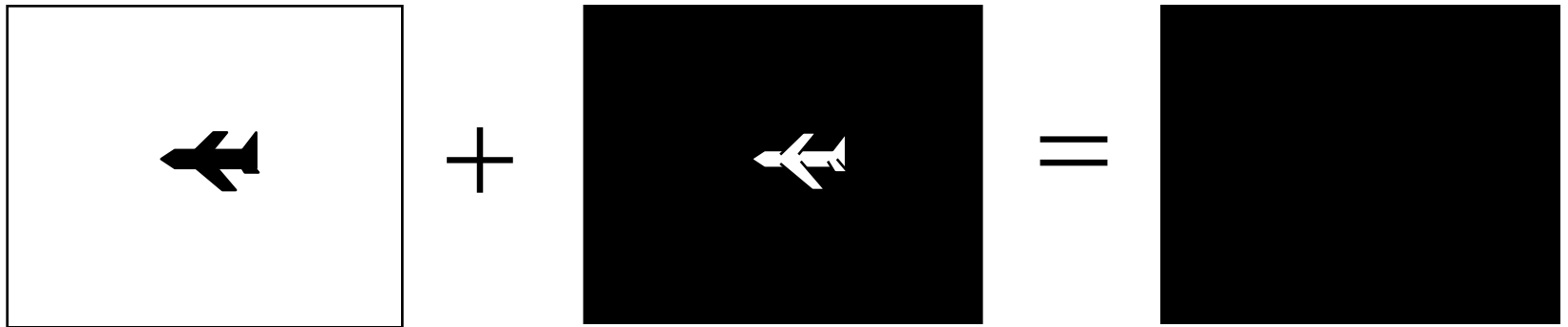

RESONANCE SCATTER

So a target on the transmitter-receiver baseline, even if it is completely stealthy, will scatter a significant amount of energy - in fact the RCS will be of the order of

$$\sigma_b = \frac{4\pi A^2}{\lambda^2}$$

The angular width of the scattering will be of the order of λ/d (radians)

which tends to favour a low frequency.

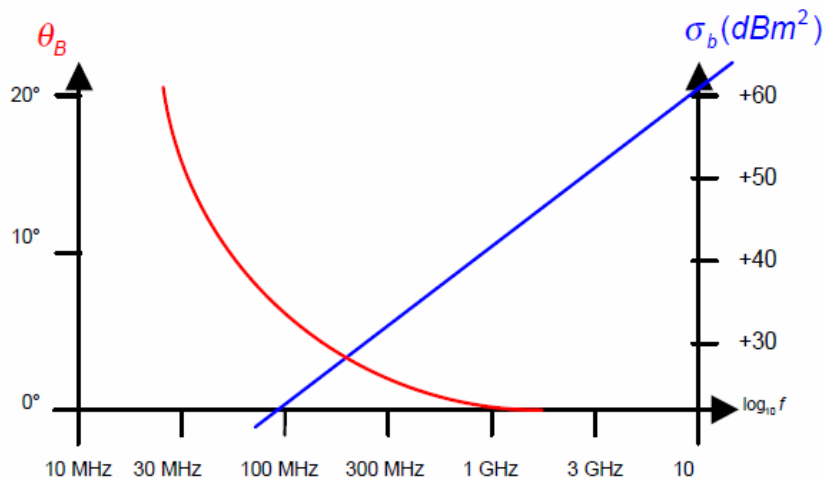

Variation of forward scatter RCS and angular width of response ($d = 10\text{m}$, $A = 10\text{m}^2$).

But a target which lies exactly on the transmitter-receiver baseline will give no range information and no Doppler information, and even for a target only slightly off-baseline the range and Doppler resolution will be poor

So whilst a forward scatter radar will be good for target detection, location and tracking will be more difficult

PERFORMANCE PREDICTION

Maximum integration dwell time is approximately

$$T_{MAX} = \left(\frac{\lambda}{A_R} \right)^{1/2}$$

For a VHF waveform with a bandwidth of 50 kHz and a dwell time of 1 second, processing gain is $G_p \approx 47$ dB.

Cast bistatic radar equation in the form:

$$(R_R)_{max} = \left(\frac{\Phi \sigma_b G_R \lambda^2 L G_p}{(4\pi)^2 (S/N)_{min} kT_0 BF} \right)^{1/2}$$

allows prediction of coverage around transmitters and receivers

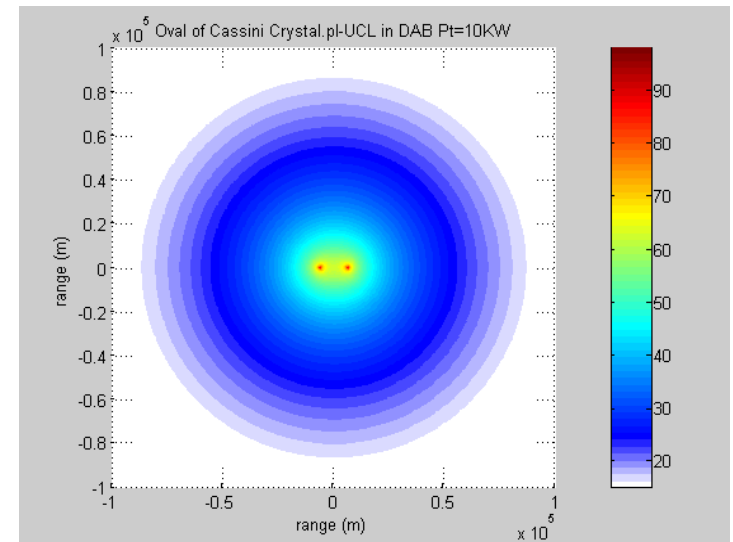

VERTICAL PLANE COVERAGE

- The performance of a passive bistatic radar system depends not only on the waveform, but also on the coverage of the illuminating sources.
- Transmitters will frequently be sited on hilltops or on tall buildings.
- The vertical-plane coverage will usually be optimized so as to avoid wasting power above the horizontal, and in some cases the beams may be tilted downwards.

$$R_{R\max} = \sqrt{\frac{P_t G_t \lambda^2 \sigma G_p}{(4\pi)^3 R_T^2 (S/N)_{\min} kT_0 BFL}}$$

- For every 10 dB reduction in $P_t G_t$ the maximum detection range R_R for a given target is reduced by a factor of $3.3 \times$

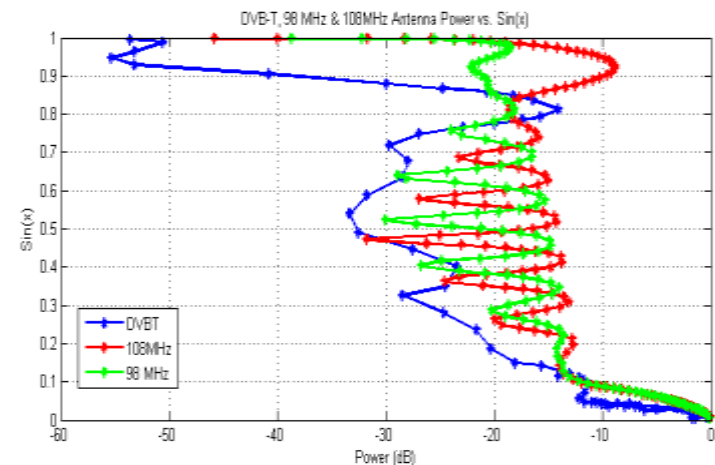
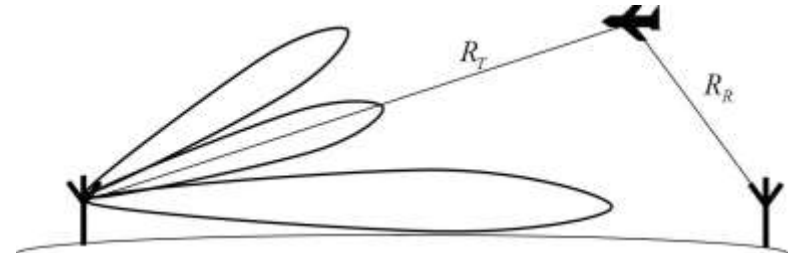

G.H. Millard, *The Introduction of Mixed-Polarization for VHF Sound Broadcasting: the Wrotham Installation*, Research Department Engineering Division, British Broadcasting Corporation, BBC RD 1982/17, September 1982.

D.W. O'Hagan, H. Kuschel, M. Ummenhofer, J. Heckenbach and J. Schell, 'A multi-frequency hybrid passive radar concept for medium range air surveillance', *IEEE AES Magazine*, Vol.27, No.10, pp6–15, October 2012.

PASSIVE BISTATIC RADAR

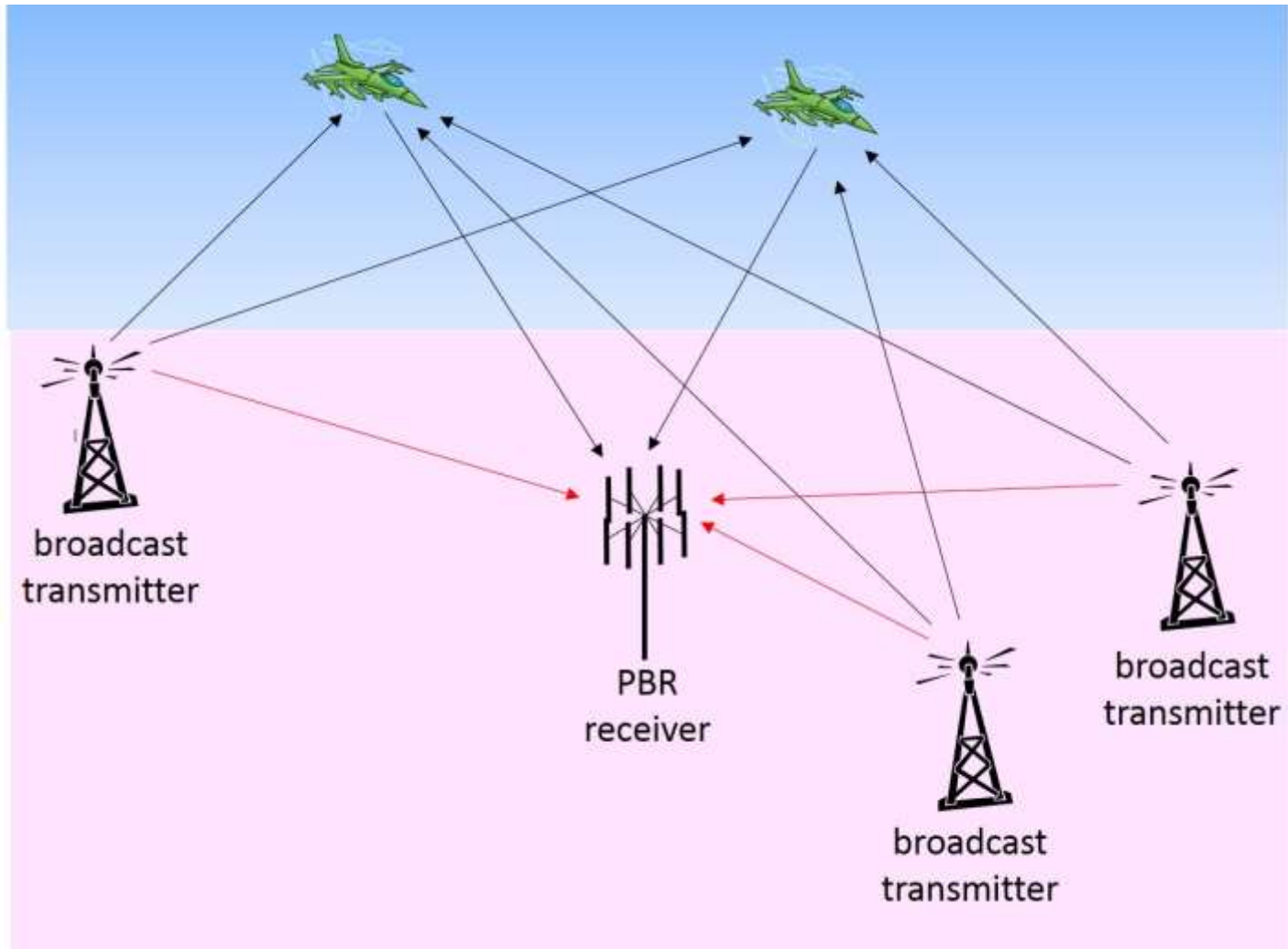

PASSIVE BISTATIC RADAR

- Broadcast and communications transmitters tend to be sited on high locations and hence achieve broad coverage.
- Since the system makes use of existing transmitters, the cost of a passive radar is likely to be much lower than a conventional radar.
- Similarly, there are no licensing issues.
- It allows the use of frequency bands (particularly VHF and UHF) that are not normally available for radar purposes. Such frequencies may be beneficial in detecting stealthy targets, since the wavelength is of the same order as the physical dimensions of the target, and forward scatter gives a relatively broad angular scatter.
- Since the receiver emits no signal of its own, and as long as the receive antenna is inconspicuous, the passive radar receiver may be undetectable and hence completely covert.
- It is difficult to deploy countermeasures against passive radar. Any jamming will have to be spread over a range of directions, diluting its effectiveness.
- Passive radar does not require any additional spectrum. For this reason it has been termed 'green radar'.
- There is an enormous range of transmissions that may be used. In practice, almost any emission can be used as the basis of a passive radar.

PASSIVE BISTATIC RADAR

- The waveforms of such transmissions are not optimized for radar purposes, so care has to be used to select the right waveforms and to process them in the optimum way.
- In many cases the transmit source is not under the control of the passive radar.
- For analog signals, the ambiguity function (resolution in range and in Doppler) depends on the instantaneous modulation, and some kinds of modulation are better than others. Digital modulation does not suffer from these problems, so is likely to be preferred.
- The waveforms are usually continuous (i.e. a duty cycle of 100%), so significant processing has to be used to suppress the direct signal and multipath in order to detect weak target echoes.
- In common with all bistatic radars, the resolution in range and Doppler is poor for targets on or close to the baseline between transmitter and receiver.

PASSIVE RADAR ILLUMINATORS

Transmission	Frequency	Modulation, Bandwidth	$P_t G_t$	Power density (note 1)
				$\Phi = \frac{P_t G_t}{4\pi R_T^2}$
HF broadcast	10–30 MHz	DSB AM, 9 kHz	50 MW	–67 to –53 dBW/m ² at $R_T = 1,000$ km
VHF FM	88–108 MHz	FM, 200 kHz	250 kW	–57 dBW/m ² at $R_T = 100$ km
Analog TV	~550 MHz	Vestigial sideband AM, 5.5 MHz	1 MW	–51 dBW/m ² at $R_T = 100$ km
DAB	~220 MHz	Digital, OFDM, 220 kHz	10 kW	–71 dBW/m ² at $R_T = 100$ km
DVB-T	~750 MHz	Digital, 6 MHz	8 kW	–72 dBW/m ² at $R_T = 100$ km
Cell phone base station (GSM)	900 MHz, 1.8 GHz	GMSK, FDMA/TDMA/FDD, 200 kHz	100 W	–71 dBW/m ² at $R_T = 10$ km
Cell phone base station (3G)	2 GHz	CDMA, 5 MHz	100W	–71 dBW/m ² at $R_T = 10$ km
WiFi 802.11	2.4 GHz	DSSS/OFDM, 5 MHz	100 mW	–41 dBW/m ² (note 2) at $R_T = 10$ m
WiMAX 802.16	2.4 GHz	QAM, 1.25–20 MHz	20W	–88 dBW/m ² at $R_T = 10$ km
GNSS	L-band	CDMA, FDMA, 1–10 MHz	200W	–134 dBW/m ² at Earth's surface
DBS TV	Ku-band, 11–12 GHz	Analog and digital	300 kW	–107 dBW/m ² at Earth's surface
Satellite SAR	9.6 GHz	Chirp pulse, 400 MHz (max.)	28 MW	–54 dBW/m ² SAR (note 3) at Earth's surface

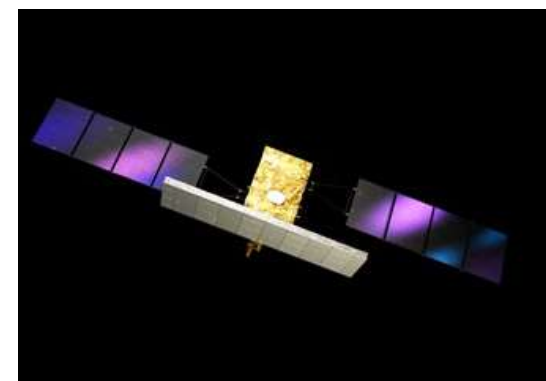

Source: [6]. Note 1: assuming free space line-of-sight propagation; Note 2: would be subject to additional attenuation due to propagation through walls; and Note 3: parameters from SARs carried by the COSMO-SkyMed series of satellites [7].

Locations of CONUS FM Stations



- 4500 FM Transmitters \geq 5 Kwatts
- 3600 FM Transmitters \geq 1 Kwatt

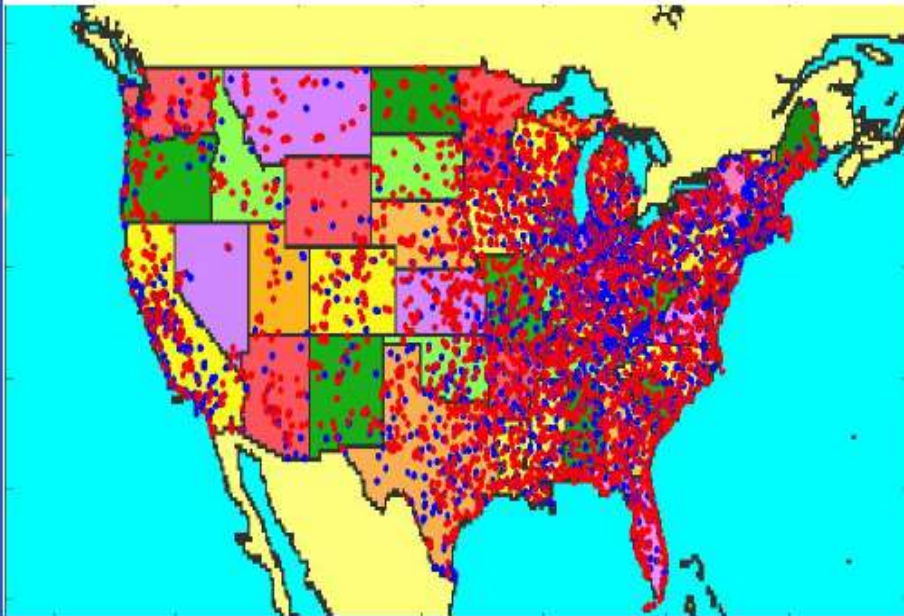

High Power FM Line-of-Sight for 1000' Targets

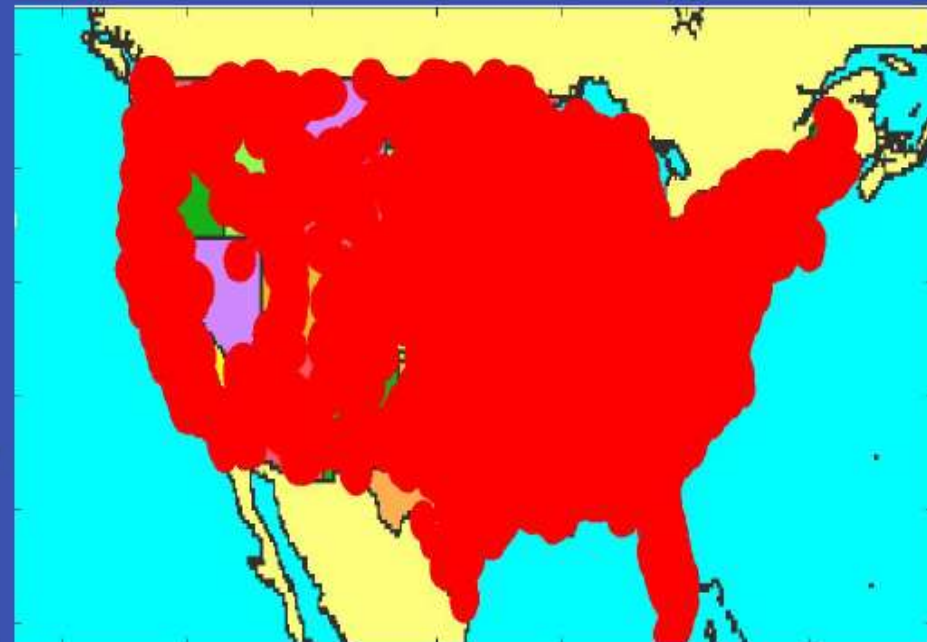

Existing commercial FM transmitters provide low altitude illumination for virtually all regions of interest in the US.

- For Europe, CIA World Factbook cites:
- >15000 FM Stations
 - >44000 TV Stations

PASSIVE RADAR WAVEFORMS

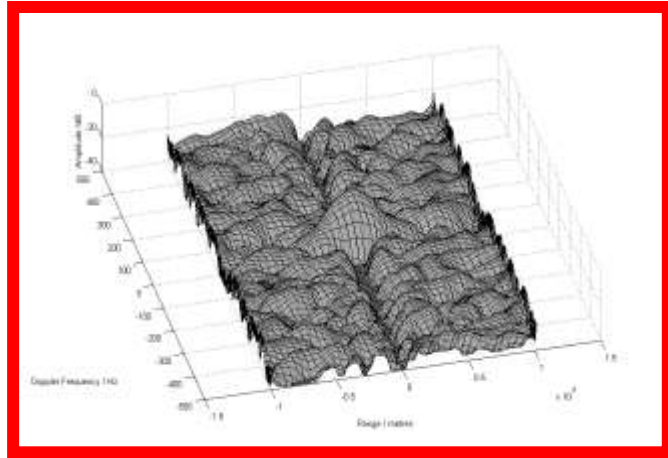

BBC Radio 4 (news) 93.5 MHz

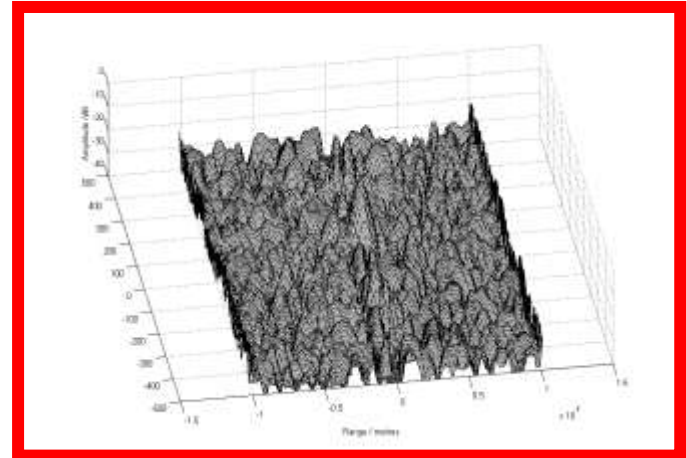

Jazz FM (fast tempo) 102.2 MHz

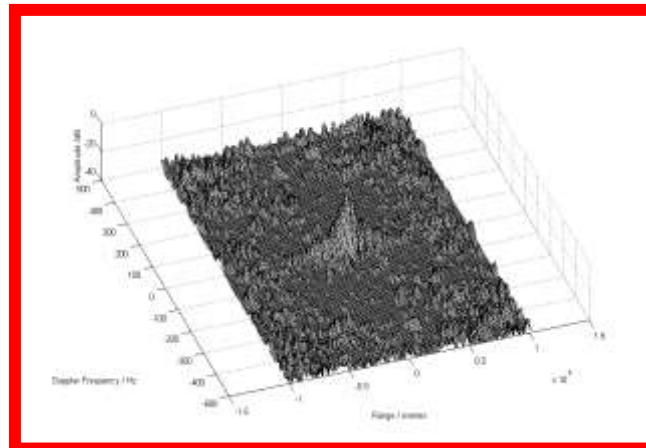

Digital Audio Broadcast 222.4 MHz

TERRESTRIAL ANALOG TV

measured spectrum of analogue (and digital) TV signals

In the UK the PAL (Phase Alternating Line) modulation format is used, in which the video information is coded as two interlaced scans of a total of 625 lines at a frame rate of 50 Hz. The start of each line is marked with a sync pulse, and the total duration of each line is 64 μ s. The video information is modulation onto a carrier as vestigial-sideband AM, coded as *luminance* (Red + Green + Blue) and two *chrominance* signals (Green – Blue) and (Red – Blue). The two chrominance subcarriers are in phase quadrature, so that they can be separately recovered. The sound information (including stereo information) is frequency-modulated onto a second carrier.

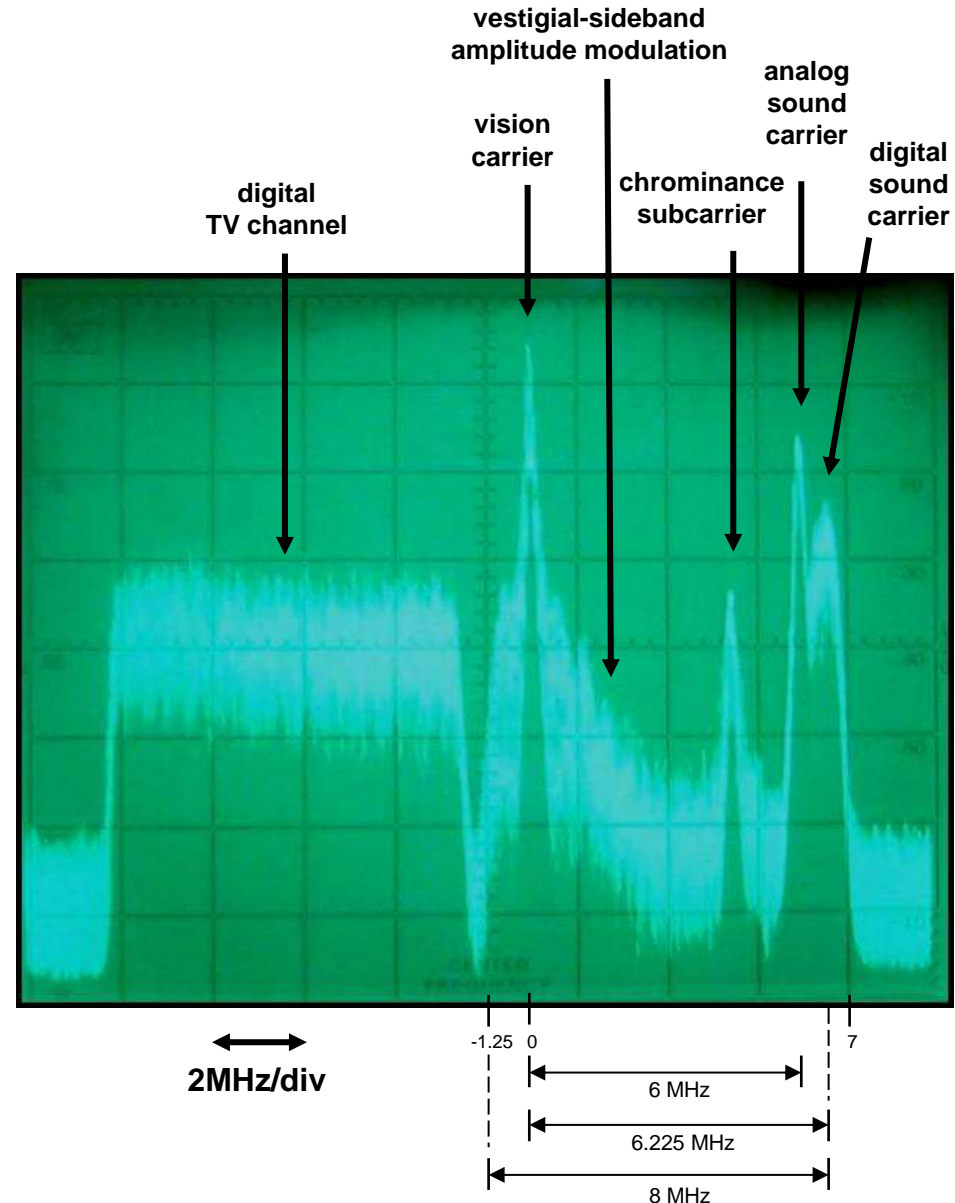

EARLY BISTATIC RADAR EXPERIMENTS AT UCL

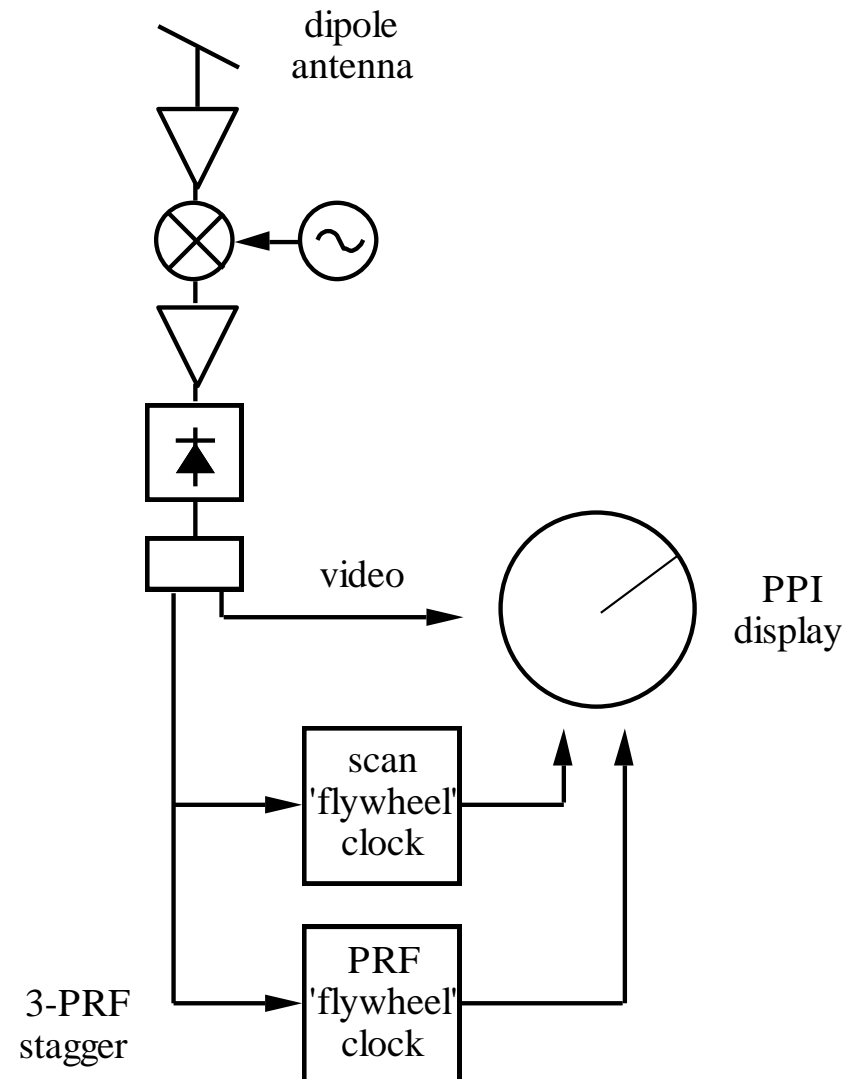
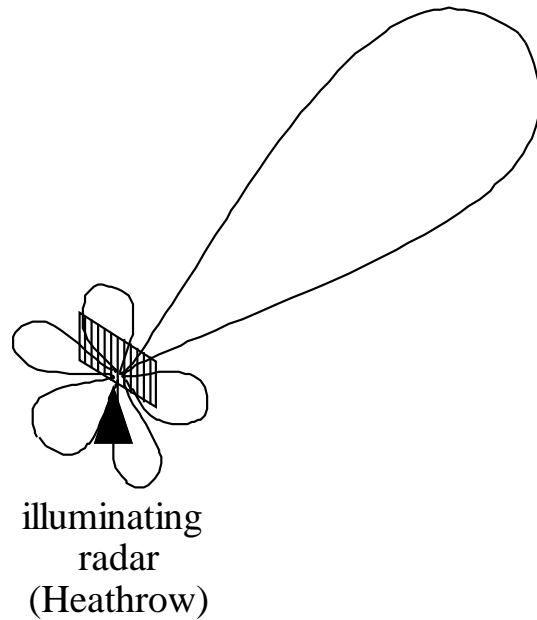

EARLY BISTATIC RADAR EXPERIMENTS AT UCL

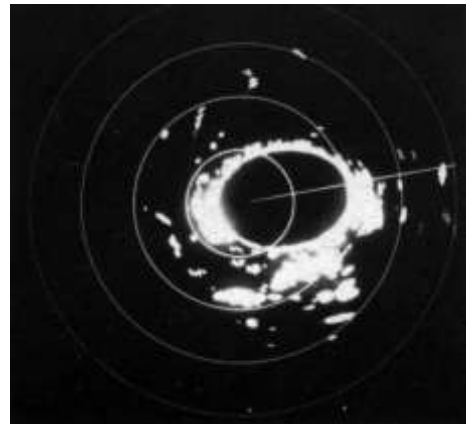
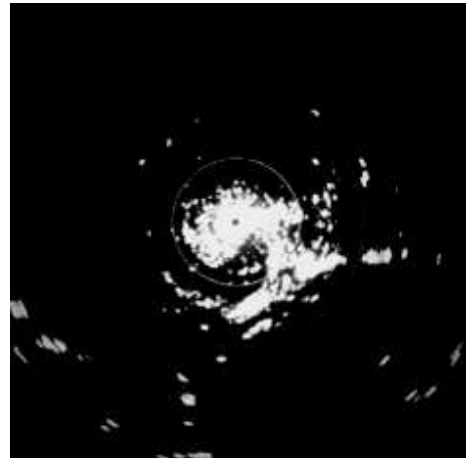

Schoenenberger, J.G. and Forrest, J.R., 'Principles of independent receivers for use with co-operative radar transmitters', *The Radio and Electronic Engineer*, Vol.52, No.2, pp93-101, February 1982.

Griffiths, H.D. and Carter, S.M., 'Provision of moving target indication in an independent bistatic radar receiver'; *The Radio and Electronic Engineer*, Vol.54, No.7/8, pp336-342, July/August 1984 .

FORWARD SCATTER VHF FM

- BBC Radio 4, 93.5 MHz, Wrotham (Kent)
- aircraft target on approach to Heathrow, crossing baseline
- receiver located so that direct signal is weak, hence beat between direct signal and Doppler-shifted echo has maximum modulation
- Doppler shift goes through zero as target crosses baseline

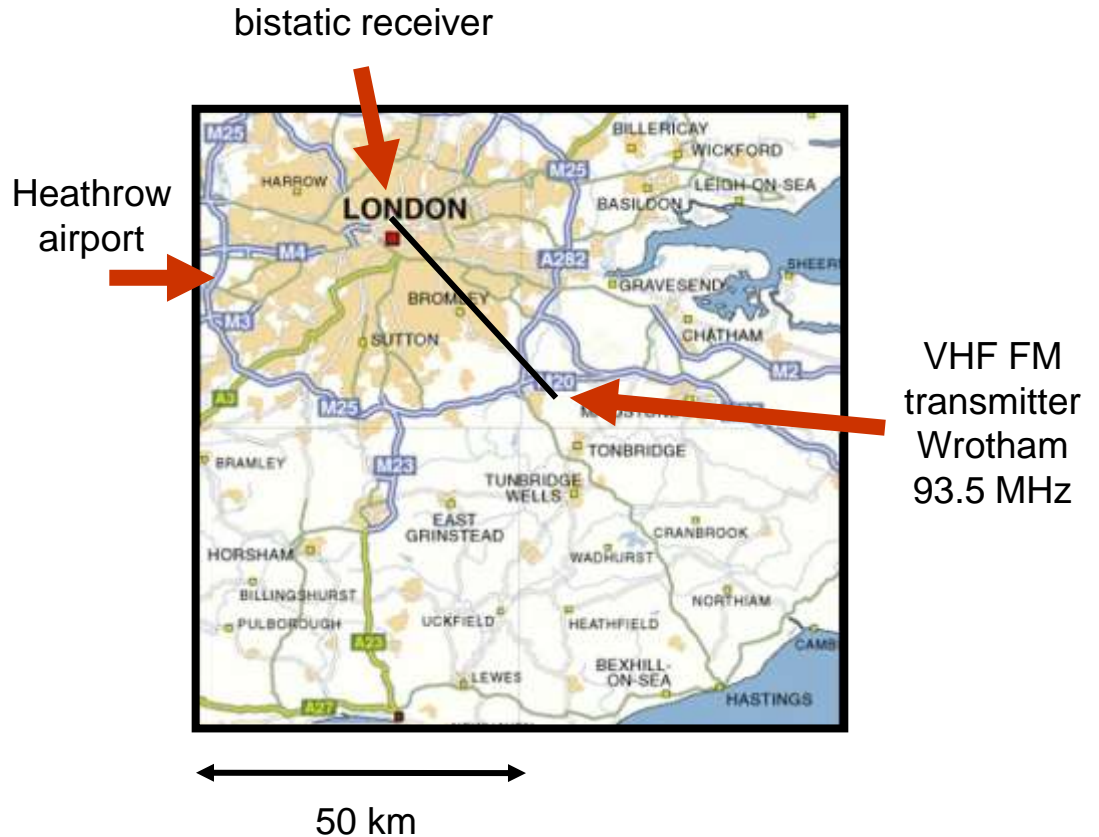



Tracking of a Cessna 172 light aircraft using FM radio transmission

Courtesy of Craig Tong and Professor Mike Inggs,
University of Cape Town

HOMELAND ALERTER HA-100

- developed by THALES and ONERA in 2005
- FM Radio band 88 – 108 MHz
- 8 vertical dipoles
- signal processing is composed of a space time algorithm to reject the direct path, estimation / correlation, regulation process and Detection / measurement. The data processing merges the detections from all 8 channels to tracks in Cartesian coordinates. The update rate is 1.5 s



AIRBUS SPACE AND DEFENCE

The passive radar from Airbus Defence and Space demonstrated its ability to detect low-flying objects in mission scenarios similar to those of various European armed forces, among other locations, in mountainous terrain with areas of major radar shadow. At the same time, the system registered the latest airspace situation in a very short time, at ranges of up to 200 kilometres. A real-time networked system, involving two devices at different locations, also demonstrated that it can even be used in areas with a particularly restricted transmitter infrastructure



MODERN PASSIVE RADAR



HA-100 Homeland Alerter - THALES (France)



GAMMA - FKIE (Germany)



AIRBUS Defence and Space (Europe)



SILENT GUARD - ERA (Czech Republic)



DLW002 (China)



AULOS - SELEX (Italy)



ALIM (Iran)

RUSSIAN PASSIVE RADAR FOR DRONE DETECTION

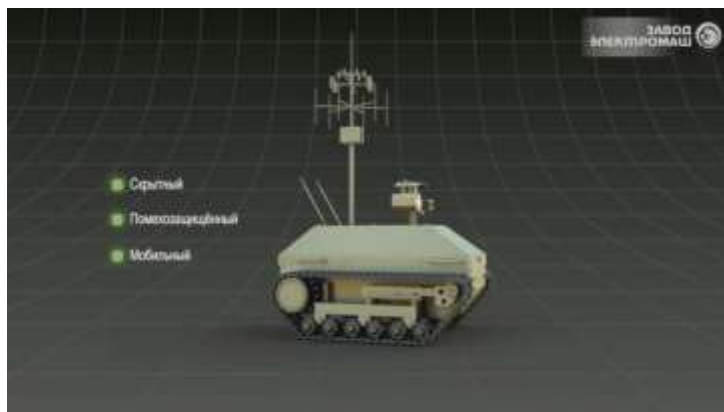
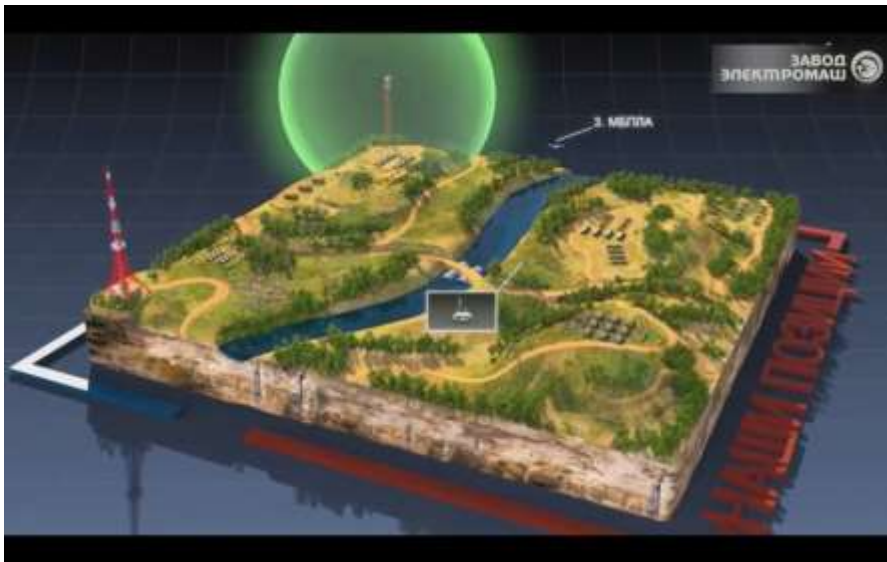

"First and foremost, the absence of active radiation makes the system very stealthy, not allowing the enemy to detect and destroy it with anti-radar means; secondly, the system detects enemy attack and reconnaissance drones which observe radio silence mode; also, the system can effectively detect sophisticated enemy stealth drones of various types"

THE FUTURE ...

- The spectrum problem and Commensal Radar
- Air Traffic Management (ATM)
- Indoor monitoring for Eldercare / Assisted Living
- Border / harbor surveillance
- Target recognition with Passive Radar
- Low cost Passive Radar
- The Intelligent Adaptive Radar Network

[All News](#)

[Defense News](#) >>

[Aerospace News](#) >>

[Aviation News](#) >>

[Global News \(AFP\)](#)

[Avionics](#)

[Combat Vehicles / Artillery](#)

[Commercial Aircraft](#)

[Communications](#)

[Contracts](#)

[Cyber Defence / IT](#)

[Engines / Power / Fuel](#)

[EOD / IEDs / Mines](#)

[Helicopters](#)

[Homeland Security](#)

[Infantry Weapons](#)

[Military Aircraft](#)

[Missiles / Rockets](#)

[MRO](#)

[NBC](#)

[Protection](#)

[Radar / EW](#) >>

[Sensors](#)

Print Email More

Passive Radar: A \$10 Billion opportunity

Passive radar is different from traditional forms of radar in that it does not emit any electromagnetic radiation. Instead, it relies on reflections from other electromagnetic signals in the atmosphere in order to provide a radar picture. Passive radar provides a number of distinct advantages that will allow it to corner a significant portion of defense, homeland security, and civilian radar markets. In addition to cost-efficiency, passive radar is also covert, an effective counter to stealth technologies, and environmentally friendly.



[*...click to enlarge](#)

The market for passive radar is still in its infancy, and few companies have developed effective, marketable systems.

However, as the technology becomes more sophisticated and affordable, more and more competitors can be expected to enter the market, particularly in defense and homeland security.

Related Research on ASDReports.com:

[The Military and Civil Aviation Passive Radar Market: 2013 - 2023](#)

By the end of 2023, SNS Research expects passive radar technology investments to account of more than \$10 billion in revenue, following a CAGR of nearly 36% between 2013 and 2023.

The "Military & Civil Aviation Passive Radar Market: 2013 – 2023" report focuses on the two markets where passive radar technology has the greatest potential: civilian aviation and military radar applications.

The report presents vendor strategies, overall depictions of potential growth in both sectors, as well as detailed qualitative and quantitative analysis of global and regional drivers and limitations on market potential from 2013 till 2023.

The report comes with an associated excel datasheet covering quantitative data from all revenue projection forecasts presented within the report.

Most read this week

- > [Orbital Set to Launch NASA's LADEE Lunar Orbiter Aboard Minotaur V Rocket](#)
Views: 3182 - Issuedate: Sep 6, 2013
- > [Boeing to Build 56 Additional A-10 Wings for US Air Force](#)
Views: 1878 - Issuedate: Sep 4, 2013
- > [Cassini Sees Saturn Storm's Explosive Power](#)
Views: 1701 - Issuedate: Sep 5, 2013
- > [HMS Dragon proves versatile in the Gulf](#)
Views: 1309 - Issuedate: Sep 2, 2013
- > [Russia sends spy ship to Syria coast: report](#)
Views: 1276 - Issuedate: Sep 2, 2013

[More popular headlines](#)

Related Market Research

- > [Flexible Display Market: Global Analysis & Forecast \(2012 - 2017\) - BY APPLICATION \(Smartphone, Tabl...](#)
Publication date: Oct 2012
- > [The Global Military Radar Market 2013-2023](#)
Publication date: Aug 2013.
- > [Millimeter Wave \(MM Wave\) Market - By Technology, Components \(Frequency,](#)

Acknowledgements

I express my thanks to all those I have worked with and learned from, and who have provided material used in this presentation

Waddah Al-Ashwal
Stuart Anderson
Chris Baker
Alessio Balleri
Shannon Blunt
Alex Charlish
Mike Cherniakov
Francesco Fioranelli
Simon Haykin
Mike Inggs
William Miceli

Matt Ritchie
Stefan Sandenbergh
Graeme Smith
Andy Stove
Craig Tong
Kenneth Tong
Robert Tough
Keith Ward
Simon Watts
Mike Wicks
Karl Woodbridge

I am grateful also to the IET A F Harvey Prize fund, THALES UK, the Royal Academy of Engineering, EPSRC, and ONR (Global) for their financial support of this work.